

Varenummer: 3901150030200
 Beskrivelse: Snekkegear med fri indgangsaksel
 VF 150A-30-HS

Mål

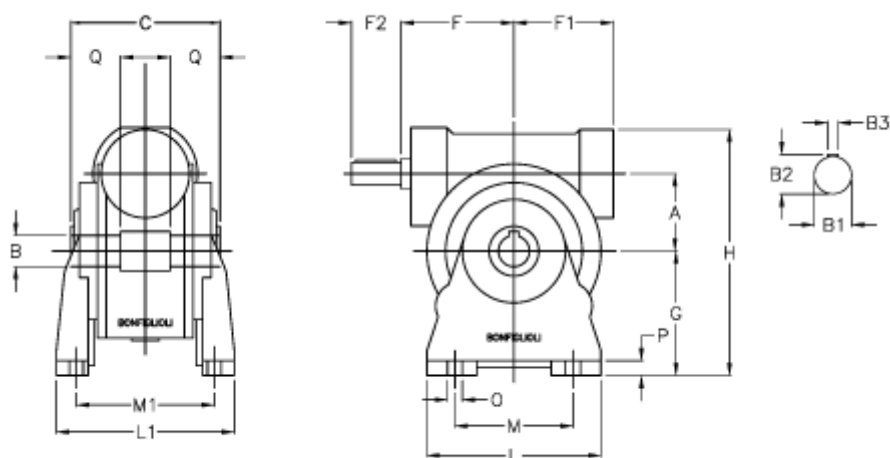

a	= 150.0	F1	= 179	P	= 20
B	= 50	g	= 220	Q	= 55.0
B1 E7	= 35	H	= 438		
B2	= 38.0	L	= 330		
B3 H9	= 10	L1	= 260		
Betegnelse	= VF 150A-xx-HS	m	= 240		
C	= 175	M1	= 211.0		
F	= 185.0	O	= 18.0		